

Note 3:

KM3000 Molex type programming lead

Background

If you have purchased a Molex plug and lead from TVRG please note this is not a programming lead but a source of the Molex plug that you can use to make a programming lead.

Alternatively, you may have purchased a Molex 15 way connector kit and pins from TVRG. If so then this guide will help you make the connection to the correct pins on the rear connector.

If using a TVRG lead you may need to relocate some of the pins depending which lead you have as per the instructions below.

The pins can be removed with a MOLEX pin removal tool or using a small jewellers screwdriver.

Pin removal

If you have to remove the pins to move them around then it is possible with care to get them out of the shell.



The pins look like a small dart and have two small wings at the side that need pressing in with a small jeweller's screwdriver in the mating side of the plug shell. Then gently pull the pin out from the back with the wire attached. They are sometimes tight but should come out by pulling on the cable with a little gentle pressure. Carefully tidy up the two wings on the pin so they stick out a little bit as in the picture. Reposition them in the correct position (9, 10, and 11) in the plug with a gentle prod from the back with a screwdriver.

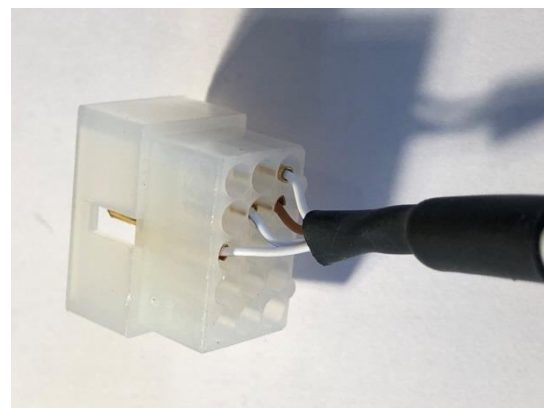
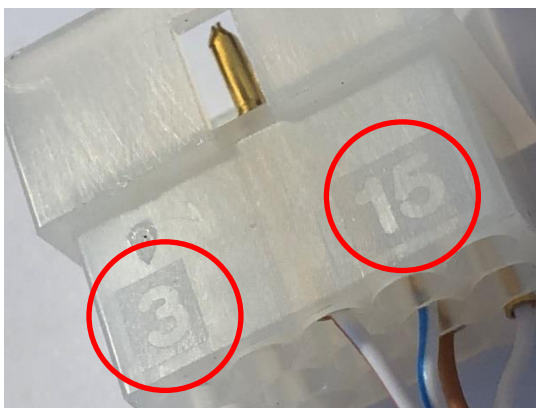

If you look carefully at the plug the pin numbers are marked on the top of the plug. There are two ribs at the bottom and the side inside the plug and matching V grooves at the bottom and side of the socket on the radio.

(This pin is not required)

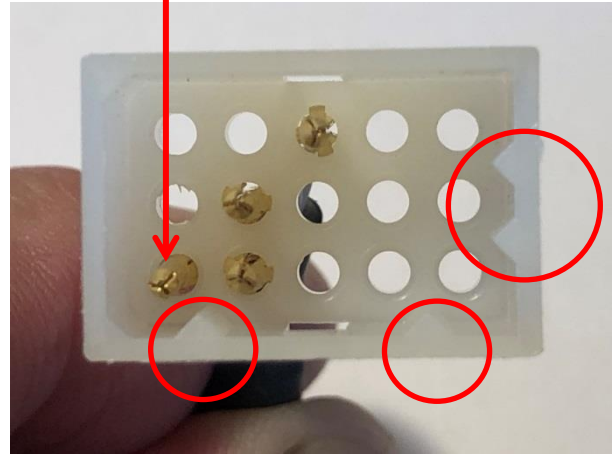
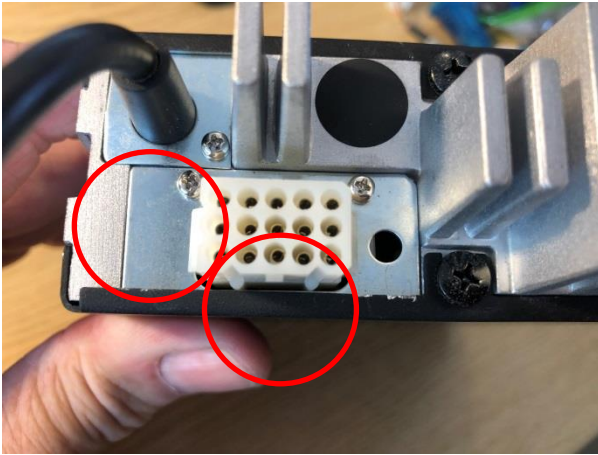

Then fit a 9 way D connector to the other end with the wires connected to the standard RS232 pin out of 2, 3 & 5 as shown below and then use this to connect it to your computer.

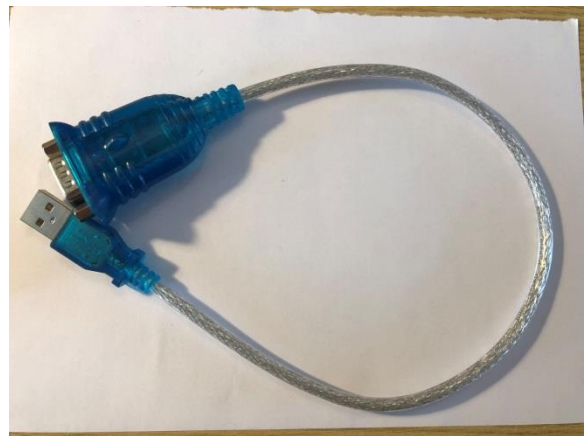

You may need to use a USB to RS232 serial interface cable if the PC you are using doesn't have a 9 way serial connector com port on it. Most new computers today have USB only. The radio programming will not work with a USB to TTL (RS232c) dongle/convertor as the +/- 5v is not enough it needs to be true RS232. The blue adaptors above are what we have used and will normally work first time.

At first the picture below can be a bit confusing; it shows the connector on the back of the radio looking into the radio. As described above there are two small ribs on the bottom of the socket at the back of the radio. You can just make them out in this drawing below as well.

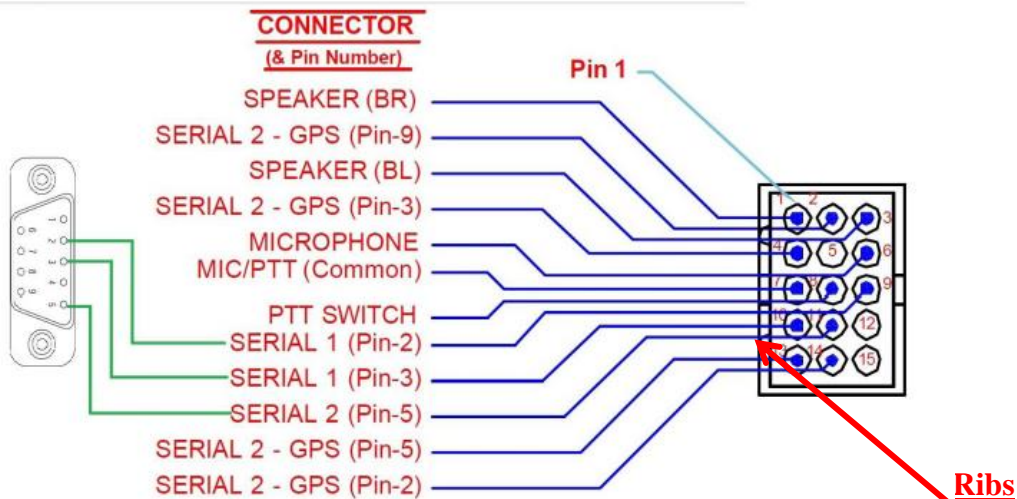

KM3000 Molex (15-Pin) Connection Diagram

As detailed above for a programming cable it is pins (9, 10, and 11). These are in the middle of the plug with pin 9 being in the middle at the top just below the single latch slot. Pins 10, 11 are at the lower part of the plug to the right of pin 9.

If you want to use an extension speaker use pins 1, 3. Looking at the back of the radio these pins are on the left hand side with the radio the correct way up.

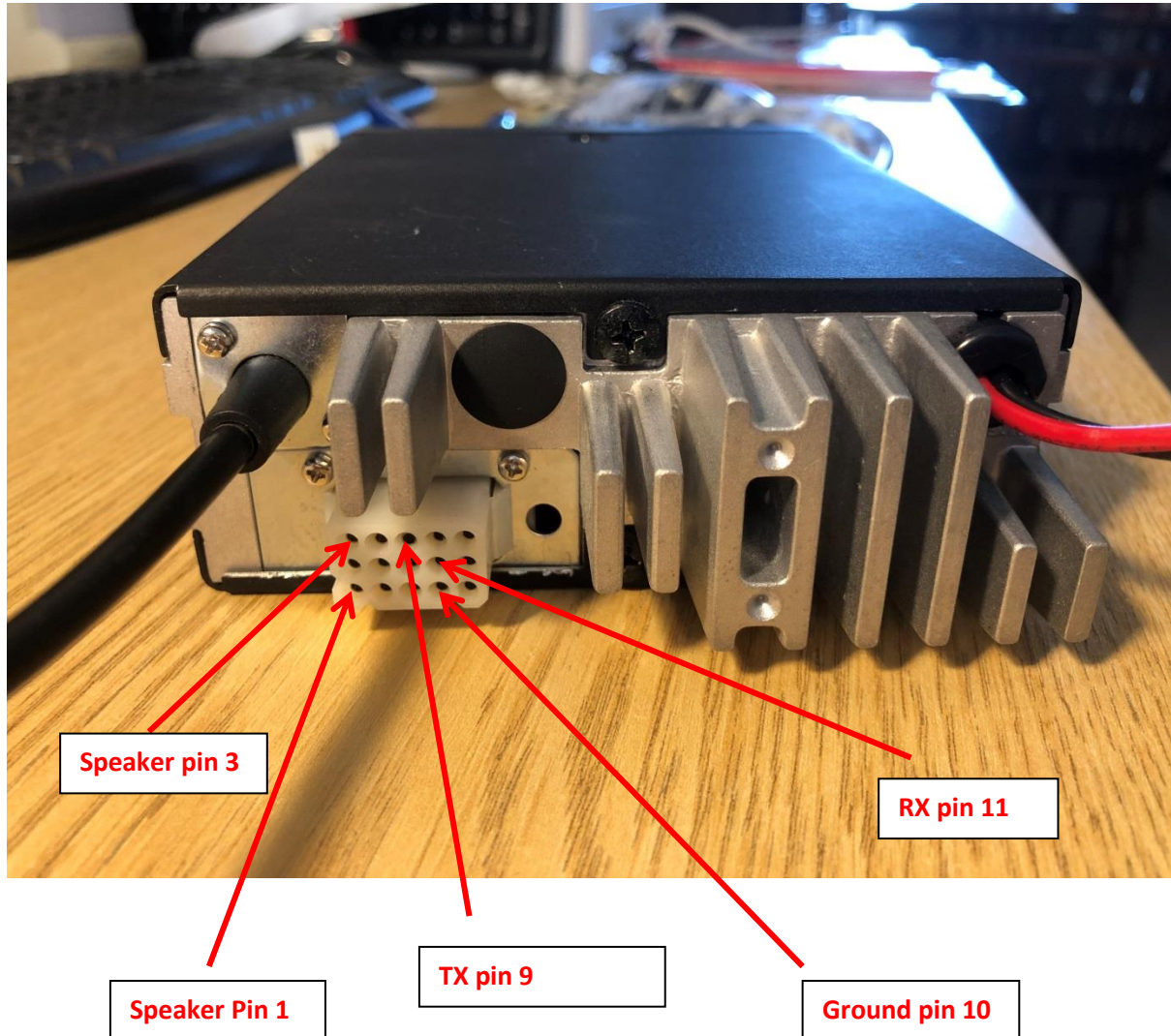

As is often with RS232 connections if it won't work try swapping the connections to pins 9 and 11 (TX & RX) over or pins 2, 3 at the 9 way D connector (TX & RX).

Hopefully this guide will enable you to produce a working programming lead.

Note 3_KM3000 4000 Molex type programming lead

TVRG 2023